

ADFOTEC

ADHESIVES ACOUSTICS FOAMS LAMINATES

Adfotec is gespecialiseerd in profielen waaronder, kantafwerk profielen, U-profielen, H-profielen, P-profielen, L-profielen, T-profielen, afdichtingsprofielen, klemprofielen, mosrubber, etc.

De Volger 25
1483 GA De Rijp

Tel: +31 (0) 299 674 267

Fax: +31 (0) 299 673 802

Mob: +31 (0) 622 529 022

Email: info@adfotec.nl

Internet www.adfotec.nl



216.00.038
EPDM 70° Shore zwart
rollengte 50 meter



216.04.407
EPDM 70° Shore zwart
rollengte 100 meter

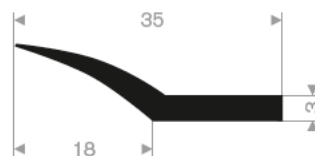

216.01.324
EPDM 70° Shore zwart
rollengte 100 meter

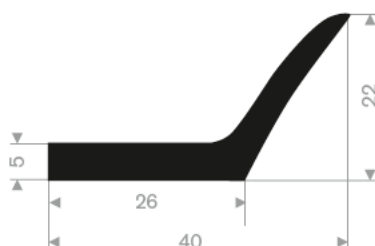

216.01.328
EPDM 70° Shore zwart
rollengte 100 meter

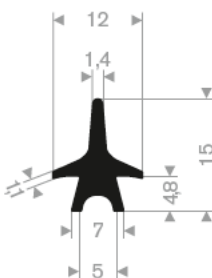

216.01.305
EPDM 70° Shore zwart
rollengte 100 meter



216.00.040
EPDM 70° Shore zwart
rollengte 30 meter

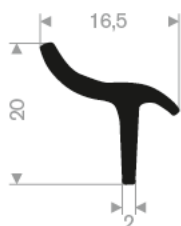

216.00.715
EPDM 70° Shore zwart
rollengte 30 meter

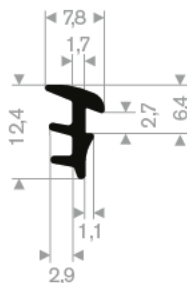

216.03.545
EPDM 65° Shore
rollengte 200 meter

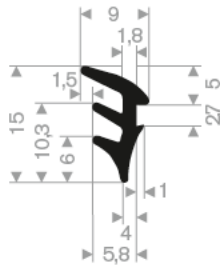

216.03.551
EPDM 65° Shore
rollengte 200 meter

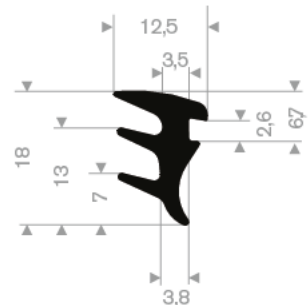

216.03.557
EPDM 65° Shore
rollengte 100 meter

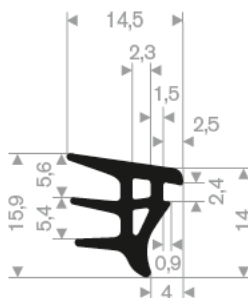

216.03.575
EPDM 65° Shore
rollengte 100 meter



216.02.202
EPDM 65° Shore
rollengte 50 meter

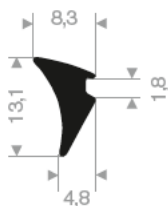

216.03.633
EPDM 70° Shore zwart
rollengte 250 meter

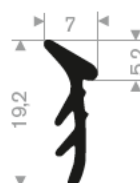

216.03.635
EPDM 70° Shore zwart
rollengte 200 meter

216.09.040
EPDM 60° Shore zwart
rollengte 5 meter

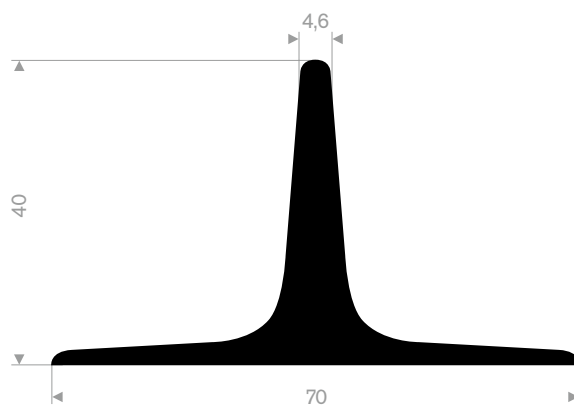

216.09.041
EPDM 60° Shore zwart
rollengte 5 meter

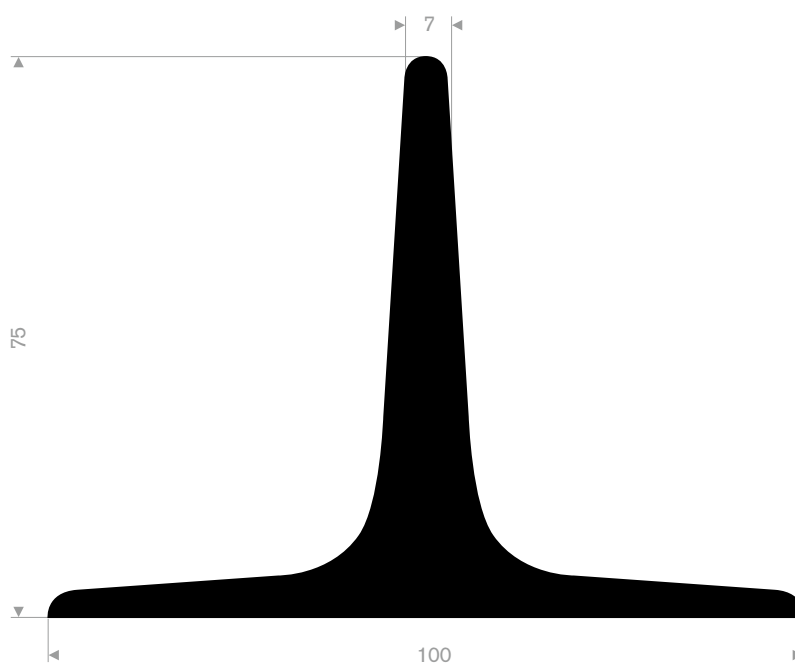

216.09.043
EPDM 60° Shore zwart
rollengte 5 meter

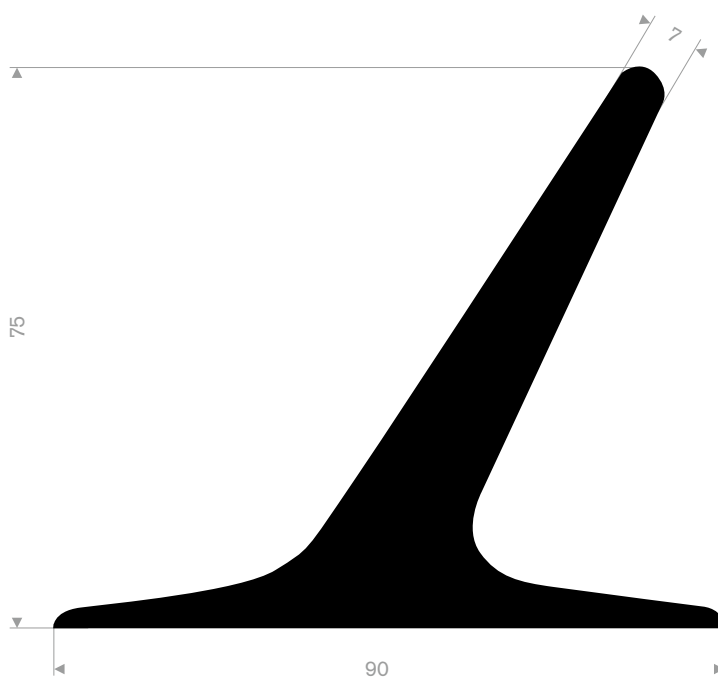

luikenpakking

hardheid 45° Shore
 toleranties ISO 3302 E2
 kwaliteit EPDM
 kleur zwart

A	B	C	code	rollengte (m)
25	15	6	215.82.515	40
25	25	10	215.82.525	20
30	20	8	215.83.020	20
30	25	10	215.83.025	20
30	30	14	215.83.030	15
35	15	6	215.83.515	25
35	20	8	215.83.520	20
35	30	14	215.83.530	15
35	35	14	215.83.535	15
40	15	6	215.84.015	20
40	20	8	215.84.020	20
40	25	10	215.84.025	15
40	30	14	215.84.030	15
40	40	18	215.84.040	15
45	20	8	215.84.520	15
50	20	8	215.85.020	15
50	30	14	215.85.030	10
50	40	18	215.85.040	10
50	50	20	215.85.050	10
60	40	18	215.86.040	10
70	40	18	215.87.040	5

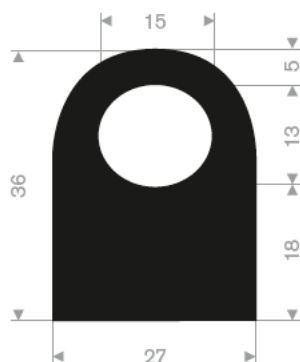
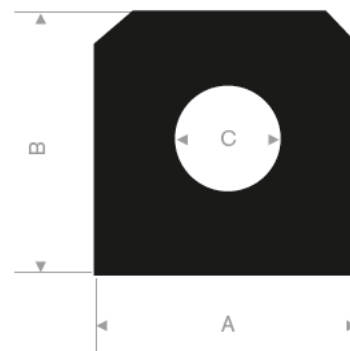

215.28.736
 hardheid 40° Shore
 rollengte 20 meter